

20 Bovenbouw kleine vrachtwagen

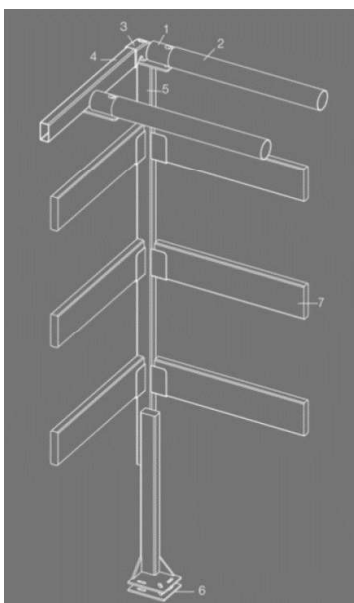

- optimale oplossing voor bestelwagens of aanhangwagens tot een lengte van 4,50 m
- stabiele constructie
- eenvoudige opbouw
- variabele lengte/hoogte
- hoogwaardige zink coating
- geen ABE-keuring nodig

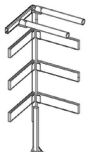

kunststof dop
voor dakbuis

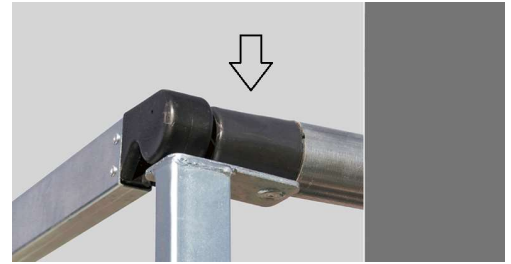

Artikel	D	Info	VPE
MD20.0260.43.1	60	zwart	1

dakbuis
60 x 1,2 x 6.200mm

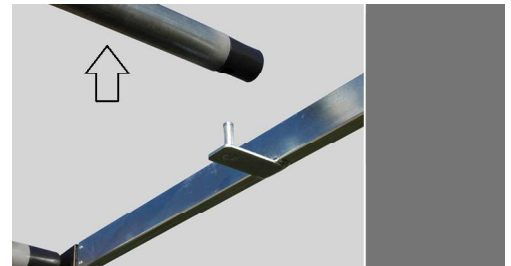

Artikel	D	Info	VPE
MD20.0160.01.1	60	staal verzinkt	1

kunststof hoekbevestiging
voor dakrail

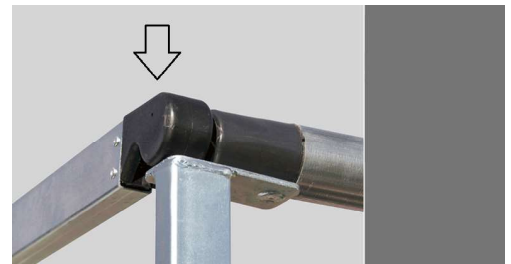

Artikel	H	B	Info	VPE
MD20.0560.43.1	60	30	zwart	1

dakrail

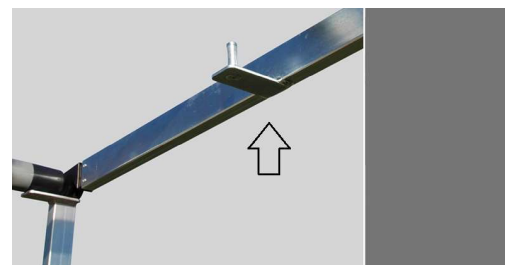

Artikel	H	b	B	Info	VPE
MD20.0325.01.1	60	2 m	30	staal verzinkt - zadel	1
MD20.0375.01.1	60	2,55 m	30	staal verzinkt - zadel	1
MD20.0320.01.1	60	2 m	30	staal verzinkt - plat	1
MD20.0300.01.1	60	2,55 m	30	staal verzinkt - plat	1

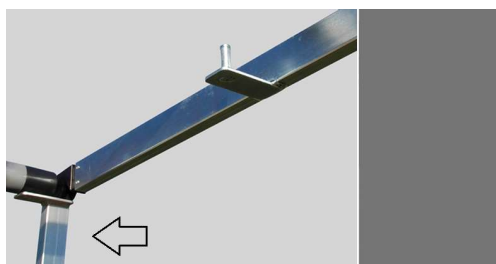

hoekpaal

Artikel	H	b	B	Info	VPE
MD20.2016.01.1	30	1,6 m	50	staal verzinkt	1
MD20.2018.01.1	30	1,8 m	50	staal verzinkt	1
MD20.2020.01.1	30	2 m	50	staal verzinkt	1

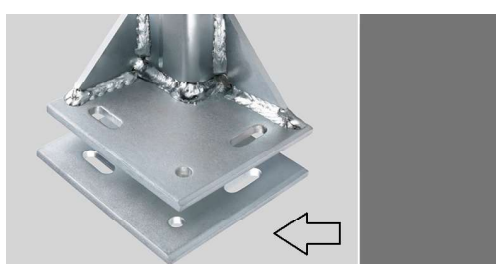

tegenplaat
voor hoekpaal

Artikel	H	B	Info	VPE
MD20.2101.01.1	120	100	staal verzinkt	1

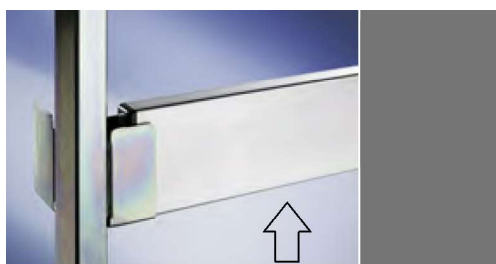

horizontale lat

Artikel	H	b	B	Info	VPE
MD20.1031.00.1	110	3 m	25	hout	1
MD20.1040.00.1	110	4 m	25	hout	1
MD20.1050.00.1	110	5 m	25	hout	1
MD20.1031.30.1	100	3 m	25	aluminium	1
MD20.1040.30.1	100	4 m	25	aluminium	1
MD20.1050.30.1	100	5 m	25	aluminium	1

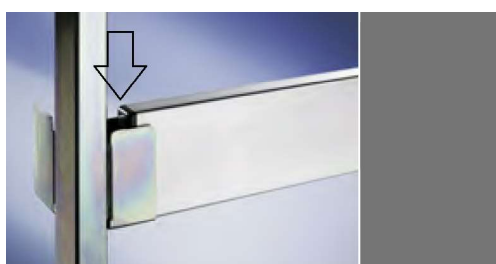

kunststof eindkap
voor horizontale aluminium lat

Artikel	H	B	Info	VPE
MD20.1025.43.1	100	25	zwart	1

31 Schuifgordijn toebehoren

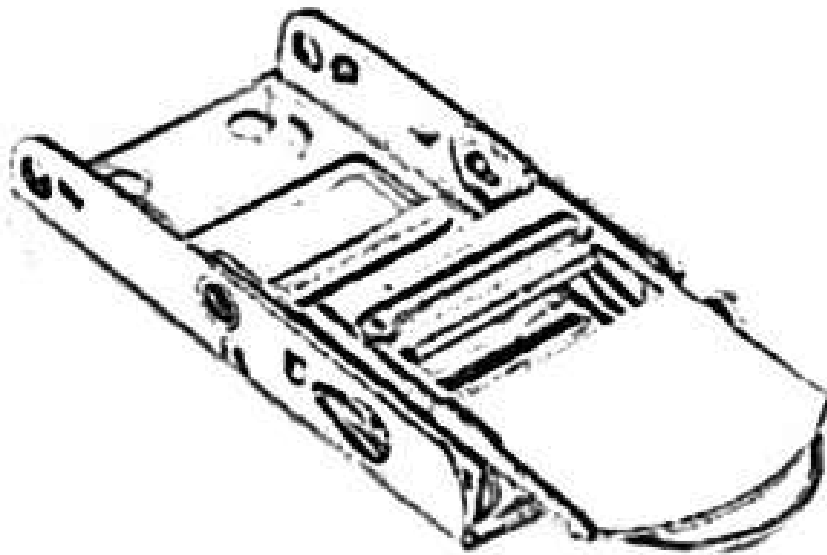

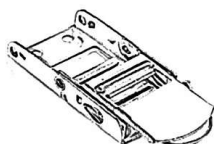

overslaggesp type 20 "spring lock"



Artikel	H	A	L	B	Info	VPE
MD31.0848.25.1	20	28	148	60	RVS	1
MD31.0848.25.50	20	28	148	60	RVS	50

overslaggesp type 20 "spring lock"
met PES band & vlakke haak M52



Artikel	H	A	L	B	Info	VPE
MD31.5542.08.1	20	28	148	60	RVS - haak: staal vernikkeld	1
MD31.5542.08.50	20	28	148	60	RVS - haak: staal vernikkeld	50
MD31.5542.20.1	20	28	148	60	RVS - haak: RVS	1
MD31.5542.20.50	20	28	148	60	RVS - haak: RVS	50

overslaggesp type 20 "spring lock"
met PES band & vlakke haak M52

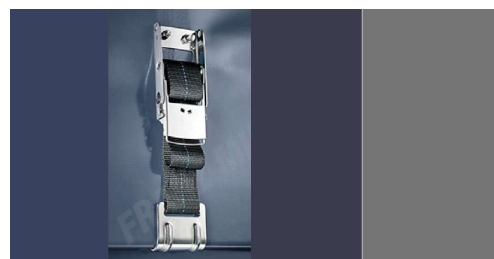

Artikel	H	A	L	B	Info	VPE
MD31.5551.08.1	20	28	148	60	RVS - haak: staal vernikkeld	1
MD31.5551.08.50	20	28	148	60	RVS - haak: staal vernikkeld	50
MD31.5551.20.1	20	28	148	60	RVS - haak: RVS	1
MD31.5551.20.50	20	28	148	60	RVS - haak: RVS	50

overslaggesp type 20 "spring lock"
met PES band & open haak

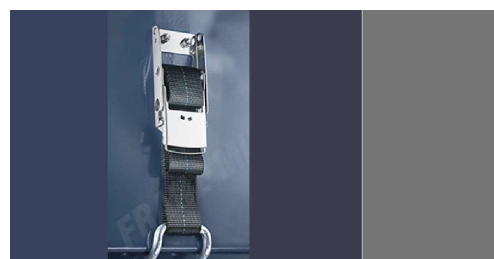

Artikel	H	A	L	B	Info	VPE
MD31.5548.20.1	20	28	148	60	RVS - haak: RVS	1
MD31.5548.20.50	20	28	148	60	RVS - haak: RVS	50

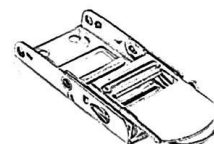

overslaggesp type 20

Artikel	H	A	L	B	Info	VPE
MD31.0648.25.1	20	28	148	60	RVS	1
MD31.0648.25.50	20	28	148	60	RVS	50



overslaggesp type 20
met PES band & vlakke haak M52

Artikel	H	A	L	B	Info	VPE
MD31.4342.08.1	20	28	148	60	RVS - haak: staal vernikkeld	1
MD31.4342.08.50	20	28	148	60	RVS - haak: staal vernikkeld	50
MD31.4342.20.1	20	28	148	60	RVS - haak: RVS	1
MD31.4342.20.50	20	28	148	60	RVS - haak: RVS	50



overslaggesp type 20
met PES band & vlakke haak M52

Artikel	H	A	L	B	Info	VPE
MD31.4351.08.1	20	28	148	60	RVS - haak: staal vernikkeld	1
MD31.4351.08.50	20	28	148	60	RVS - haak: staal vernikkeld	50
MD31.4351.20.1	20	28	148	60	RVS - haak: RVS	1
MD31.4351.20.50	20	28	148	60	RVS - haak: RVS	50

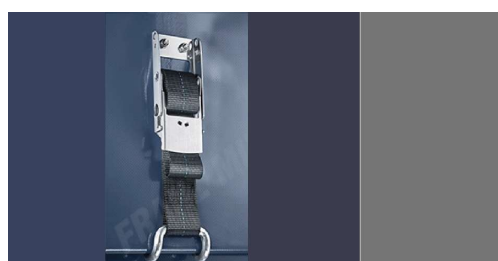

overslaggesp type 20
met PES band & open haak

Artikel	H	A	L	B	Info	VPE
MD31.4348.20.1	20	28	148	60	RVS - haak: RVS	1
MD31.4348.20.50	20	28	148	60	RVS - haak: RVS	50

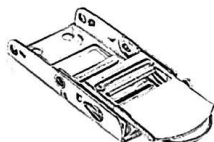

overslaggesp



Artikel	H	A	L	B	Info	VPE
MD31.0948.20.1	24	28	152	57	RVS	1
MD31.0948.20.50	24	28	152	57	RVS	50

overslaggesp
met PES band & vlakke haak M52

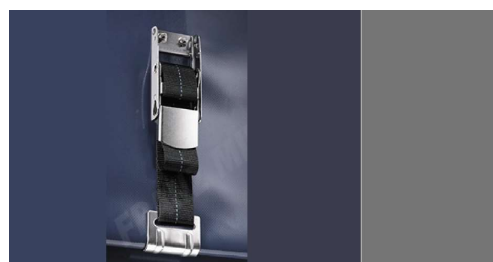

Artikel	H	A	L	B	Info	VPE
MD31.1342.08.1	24	28	152	57	RVS - haak: staal vernikkeld	1
MD31.1342.08.50	24	28	152	57	RVS - haak: staal vernikkeld	50
MD31.1342.20.1	24	28	152	57	RVS - haak: RVS	1
MD31.1342.20.50	24	28	152	57	RVS - haak: RVS	50

overslaggesp
met PES band & vlakke haak M52

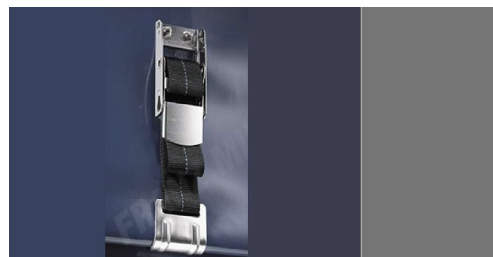

Artikel	H	A	L	B	Info	VPE
MD31.1351.08.1	24	28	152	57	RVS - haak: staal vernikkeld	1
MD31.1351.08.50	24	28	152	57	RVS - haak: staal vernikkeld	50
MD31.1351.20.1	24	28	152	57	RVS - haak: RVS	1
MD31.1351.20.50	24	28	152	57	RVS - haak: RVS	50

overslaggesp
met PES band & open haak

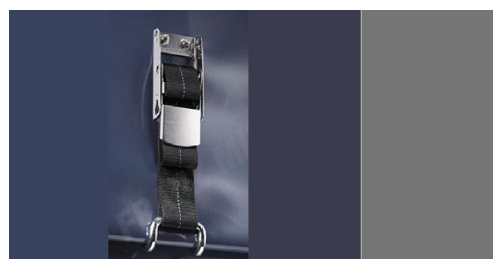

Artikel	H	A	L	B	Info	VPE
MD31.1348.20.1	24	28	152	57	RVS - haak: RVS	1
MD31.1348.20.50	24	28	152	57	RVS - haak: RVS	50

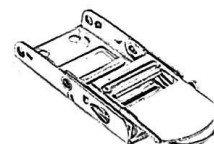

overslaggesp tysafe

Artikel	H	A	L	B	Info	VPE
MD31.0548.20.1	22	28	130	59	RVS	1
MD31.0548.20.50	22	28	130	59	RVS	50
MD31.0551.20.1	22	28	130	59	RVS - mét rem	1
MD31.0551.20.50	22	28	130	59	RVS - mét rem	50



overslaggesp tysafe met rem
met PES band & vlakke haak M52

Artikel	H	A	L	B	Info	VPE
MD31.1542.08.1	22	28	130	59	RVS - haak: staal vernikkeld	1
MD31.1542.08.50	22	28	130	59	RVS - haak: staal vernikkeld	50
MD31.1542.20.1	22	28	130	59	RVS - haak: RVS	1
MD31.1542.20.50	22	28	130	59	RVS - haak: RVS	50

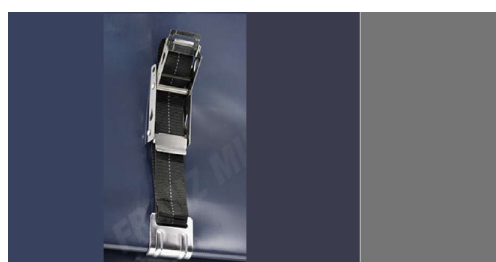

overslaggesp tysafe met rem
met PES band & vlakke haak M52

Artikel	H	A	L	B	Info	VPE
MD31.1551.08.1	22	28	130	59	RVS - haak: staal vernikkeld	1
MD31.1551.08.50	22	28	130	59	RVS - haak: staal vernikkeld	50
MD31.1551.20.1	22	28	130	59	RVS - haak: RVS	1
MD31.1551.20.50	22	28	130	59	RVS - haak: RVS	50
MD31.1554.20.1	22	28	130	59	RVS - haak: RVS	1
MD31.1554.20.50	22	28	130	59	RVS - haak: RVS	50

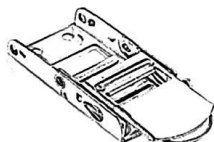

overslaggesp tysafe
met PES band & open haak

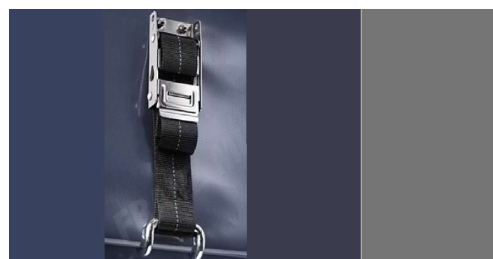

Artikel	H	A	L	B	Info	VPE
MD31.1642.08.1	22	28	130	59	RVS - haak: staal vernikkeld	1
MD31.1642.08.50	22	28	130	59	RVS - haak: staal vernikkeld	50
MD31.1642.20.1	22	28	130	59	RVS - haak: RVS	1
MD31.1642.20.50	22	28	130	59	RVS - haak: RVS	50
MD31.1555.08.1	22	28	130	59	RVS - haak: staal vernikkeld	1
MD31.1555.08.50	22	28	130	59	RVS - haak: staal vernikkeld	50
MD31.1555.20.1	22	28	130	59	RVS - haak: RVS	1
MD31.1555.20.50	22	28	130	59	RVS - haak: RVS	50
MD31.1548.20.1	22	28	130	59	RVS - haak: RVS	1
MD31.1548.20.50	22	28	130	59	RVS - haak: RVS	50

overslaggesp direct
met 30mm verstelbare schroef



Artikel	H	A	L	B	Info	VPE
MD31.0448.20.1	21	28	160	60	RVS	1
MD31.0448.20.50	21	28	160	60	RVS	50

overslaggesp direct
met 40mm verstelbare schroef



Artikel	H	A	L	B	Info	VPE
MD31.0048.20.1	21	28	160	60	RVS	1
MD31.0048.20.50	21	28	160	60	RVS	50

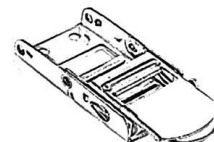

overslaggesp quick slide
met 30mm verstelbare schroef

Artikel	H	A	L	B	Info	VPE
MD31.0160.43.1	24	28	82	60	pvc zwart	1
MD31.0160.43.50	24	28	82	60	pvc zwart	50



geleidingsprofiel
voor overslaggesp quick slide
(4 gaten: 5,5mm)

Artikel	H	L	B	Info	VPE
MD31.0263.20.1	18	180	63	RVS	1
MD31.0263.20.50	18	180	63	RVS	50



tegenplaat
met bout M6 x 14mm

Artikel	A	L	B	Info	VPE
MD31.2428.20.10	28	45	20	RVS	10
MD31.2428.20.100	28	45	20	RVS	100



vlakke haak M52

Artikel	H	B	s	Info	VPE
MD31.2342.08.1	42	65	3	staal vernikkeld	1
MD31.2342.08.100	42	65	3	staal vernikkeld	100
MD31.2342.20.1	42	65	3	RVS	1
MD31.2342.20.100	42	65	3	RVS	100

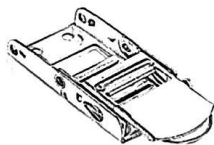

vlakke haak M52



Artikel	H	B	s	Info	VPE
MD31.2351.08.1	56	62	3	staal vernikkeld	1
MD31.2351.08.100	56	62	3	staal vernikkeld	100
MD31.2351.20.1	56	62	3	RVS	1
MD31.2351.20.100	56	62	3	RVS	100

open haak

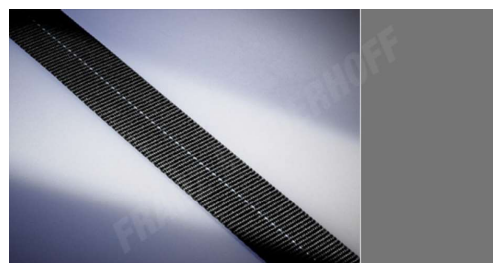

Artikel	B	s	Info	VPE
MD31.2150.01.1	50	10	staal verzinkt	1

spanband
PES - 2.400kg

Artikel	L	B	s	Info	VPE
MD31.2248.00.100	100	44	2,3	zwart	100

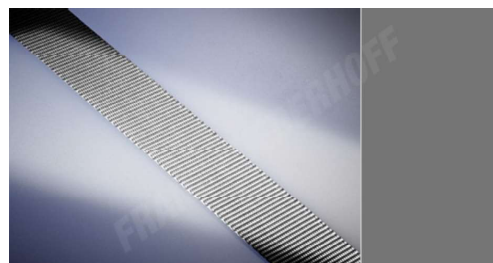
spanband
PES - 2.400kg

Artikel	L	B	s	Info	VPE
MD31.2248.45.100	100	44	2,3	zilver	100

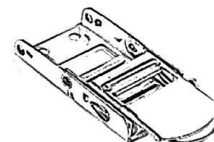

spanband mét vlakke haak M52 (staal vernikkeld)
PES - 2.400kg

Artikel	L	B	s	Info	VPE
MD31.2665.08.1	650	44	2,3	zwart - haak: staal vernikkeld	1
MD31.2665.08.50	650	44	2,3	zwart - haak: staal vernikkeld	50
MD31.2665.43.1	650	44	2,3	zwart - haak: RVS	1
MD31.2665.43.50	650	44	2,3	zwart - haak: RVS	50



spanband mét vlakke haak M52 (staal vernikkeld)
PES - 2.400kg

Artikel	L	B	s	Info	VPE
MD31.2665.28.1	650	44	2,3	zilver - haak: staal vernikkeld	1
MD31.2665.28.50	650	44	2,3	zilver - haak: staal vernikkeld	50
MD31.2665.44.1	650	44	2,3	zilver - haak: RVS	1
MD31.2665.44.50	650	44	2,3	zilver - haak: RVS	50



spanband mét vlakke haak M52 (staal vernikkeld)
PES - 2.400kg

Artikel	L	B	s	Info	VPE
MD31.2465.08.1	650	44	2,3	zwart - haak: staal vernikkeld	1
MD31.2465.08.50	650	44	2,3	zwart - haak: staal vernikkeld	50
MD31.2465.43.1	650	44	2,3	zwart - haak: RVS	1
MD31.2465.43.50	650	44	2,3	zwart - haak: RVS	50

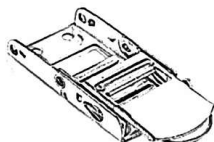

spanband mét vlakke haak M52 (staal vernikkeld)
PES - 2.400kg



Artikel	L	B	s	Info	VPE
MD31.2465.28.1	650	44	2,3	zilver - haak: staal vernikkeld	1
MD31.2465.28.50	650	44	2,3	zilver - haak: staal vernikkeld	50
MD31.2465.44.1	650	44	2,3	zilver - haak: RVS	1
MD31.2465.44.50	650	44	2,3	zilver - haak: RVS	50

spanband mét open haak (staal verzinkt)
PES - 2.400kg



Artikel	L	B	s	Info	VPE
MD31.2065.43.1	650	44	2,3	zwart - haak: RVS	1
MD31.2065.43.50	650	44	2,3	zwart - haak: RVS	50
MD31.2065.44.1	650	44	2,3	zilver - haak: RVS	1
MD31.2065.44.50	650	44	2,3	zilver - haak: RVS	50

runner gelagerd
voor EDSCHA rail type a-b-c



Artikel	D	A	L	s	Br	Bst	Info	VPE
MD31.3445.01.1	35	28	105	5	30	45	staal verzinkt	1
MD31.3445.01.50	35	28	105	5	30	45	staal verzinkt	50

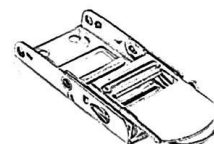

runner gelagerd
voor EDSCHA rail type a-b-c
gleuf 50mm

Artikel	D	L	s	Br	Bst	Info	VPE
MD31.4050.01.1	35	60	5	30	65	staal verzinkt	1
MD31.4050.01.50	35	60	5	30	65	staal verzinkt	50
MD31.3265.01.1	35	60	5	30	65	staal verzinkt	1
MD31.3265.01.50	35	60	5	30	65	staal verzinkt	50



runner gelagerd (hoek)
voor EDSCHA rail type a-b-c

Artikel	D	A	L	s	Br	Bst	Info	VPE
MD31.3635.01.1	35	28	123	5	30	40	staal verzinkt	1
MD31.3635.01.50	35	28	123	5	30	40	staal verzinkt	50
MD31.3435.01.1	35	28	128	5	30	40	staal verzinkt	1
MD31.3435.01.50	35	28	128	5	30	40	staal verzinkt	50



dubbele runner gelagerd (enkelzijdig)
voor EDSCHA rail
gleuf 50mm

Artikel	D	L	s	Br	Bst	Info	VPE
MD31.3442.01.1	32	60	5	19	75	staal verzinkt	1
MD31.3442.01.50	32	60	5	19	75	staal verzinkt	50

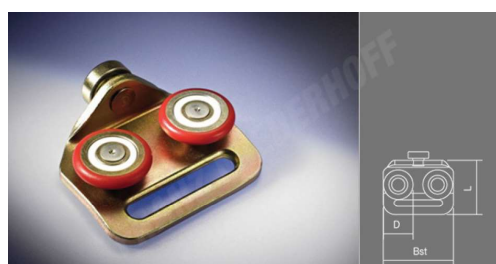

dubbele runner gelagerd (enkelzijdig +)
voor EDSCHA rail
gleuf 50mm

Artikel	D	L	s	Br	Bst	Info	VPE
MD31.3403.01.1	32	67	5	35	25	staal verzinkt	1
MD31.3403.01.50	32	67	5	35	25	staal verzinkt	50

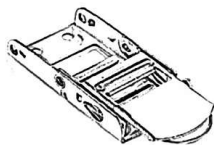

runner RVS gelagerd
voor schmitz rail



Artikel	D	A	L	s	Br	Bst	Info	VPE
MD31.3245.01.1	37	28	105	5	30	45	staal verzinkt	1
MD31.3245.01.50	37	28	105	5	30	45	staal verzinkt	50

runner RVS gelagerd
voor schmitz rail
gleuf 50mm



Artikel	D	L	s	Br	Bst	Info	VPE
MD31.3250.01.1	37	61	5	30	65	staal verzinkt	1
MD31.3250.01.50	37	61	5	30	65	staal verzinkt	50

runner RVS gelagerd
voor schmitz rail



Artikel	D	A	L	s	Br	Bst	Info	VPE
MD31.3228.01.1	37	28	120	5	30	40	staal verzinkt	1
MD31.3228.01.50	37	28	120	5	30	40	staal verzinkt	50

runner gelagerd
voor EDSCHA rail type a-b-c



Artikel	D	A	L	s	Br	Bst	Info	VPE
MD31.3477.01.1	29	28	77	3	29	45	staal verzinkt	1
MD31.3477.01.50	29	28	77	3	29	45	staal verzinkt	50

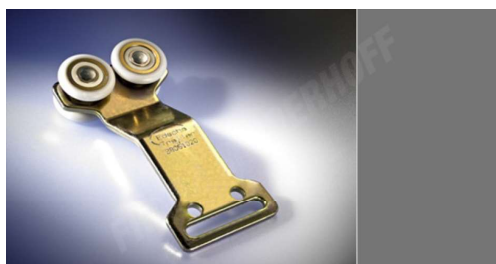
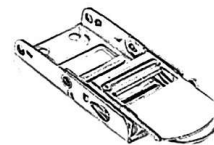

dubbele runner gelagerd (hoek)
voor EDSCHA rail type a-b-c

Artikel	D	A	L	s	Br	Bst	Info	VPE
MD31.3475.01.1	29	29	160	5	29	75	staal verzinkt	1
MD31.3475.01.50	29	29	160	5	29	75	staal verzinkt	50



runner gelagerd
voor kleine aluminium rails

Artikel	D	A	L	s	Br	Bst	Info	VPE
MD31.3624.01.1	30,5	28	120	4	25	35	staal verzinkt	1
MD31.3624.01.50	30,5	28	120	4	25	35	staal verzinkt	50



dubbele runner gelagerd
voor kleine aluminium rails

Artikel	D	A	L	s	Br	Bst	Info	VPE
MD31.3666.01.1	30,5	28	63	4	24	66	staal verzinkt	1



runner
voor stalen rail type 40-52

Artikel	D	A	L	s	Br	Bst	Info	VPE
MD31.3740.01.1	37	28	120	4	27	35	staal verzinkt	1
MD31.3740.01.50	37	28	120	4	27	35	staal verzinkt	50

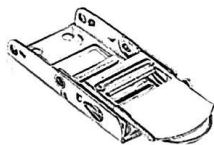

runner
voor stalen rail type 40-52
gleuf 50mm



Artikel	D	L	s	Br	Bst	Info	VPE
MD31.3750.01.1	37	62	5	27	65	staal verzinkt	1
MD31.3750.01.50	37	62	5	27	65	staal verzinkt	50

runner
voor kleine aluminium rails



Artikel	D	A	L	s	Br	Bst	Info	VPE
MD31.3140.01.1	27	28	117	4	28	35	staal verzinkt	1
MD31.3140.01.50	27	28	117	4	28	35	staal verzinkt	50

runner
voor EDSCHA spr-4
gleuf 50mm

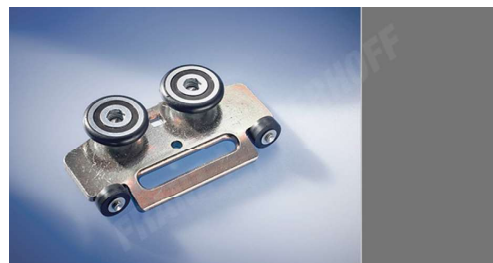

Artikel	D	L	s	Br	Bst	Info	VPE
MD31.3432.01.1	32	102	5	20	50	staal verzinkt	1
MD31.3432.01.50	32	102	5	20	50	staal verzinkt	50
MD31.3432.43.10	32					reserve runner	10
MD31.3442.43.10		76				veiligheidsclip	10

runner RVS gelagerd



Artikel	D	A	L	s	Br	Bst	Info	VPE
MD31.3124.01.1	24	28	117	4	23	35	staal verzinkt	1
MD31.3124.01.50	24	28	117	4	23	35	staal verzinkt	50

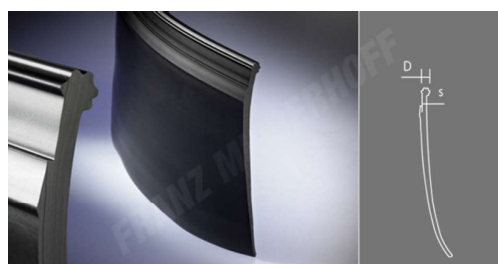
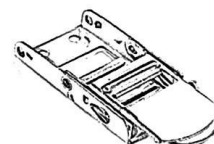

afsluitrubber
BR33P

Artikel	D	L	s	Info	VPE
MD31.3236.45.1	6,35	8,5 m	3,5	grijs	1
MD31.3136.45.1	6,35	14 m	3,5	grijs	1
MD31.3236.43.1	6,35	8,5 m	3,5	zwart	1
MD31.3136.43.1	6,35	14 m	3,5	zwart	1
MD31.3436.43.1	6,35	25 m	3,5	zwart	1



afsluitrubber
BR4P - 25mm breedte

Artikel	D	L	s	Info	VPE
MD31.3204.45.1	7	8,5 m	4	grijs	1
MD31.3104.45.1	7	14 m	4	grijs	1
MD31.3204.43.1	7	8,5 m	4	zwart	1
MD31.3104.43.1	7	14 m	4	zwart	1

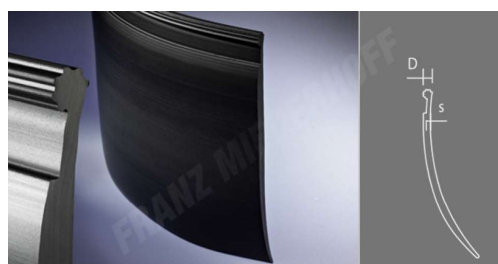

afsluitrubber
BR6P

Artikel	D	L	s	Info	VPE
MD31.3206.45.1	6,25	8,5 m	3	grijs	1
MD31.3106.45.1	6,25	14 m	3	grijs	1
MD31.3206.43.1	6,25	8,5 m	3	zwart	1
MD31.3106.43.1	6,25	14 m	3	zwart	1

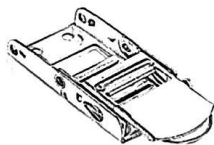

tegenplaat
met bout M6 x 14mm



Artikel	A	L	B	Info	VPE
MD31.2428.20.10	28	45	20	RVS	10
MD31.2428.20.100	28	45	20	RVS	100
MD31.2828.20.10	28	45	20	RVS	10
MD31.2828.20.100	28	45	20	RVS	100

bout huck
K = klembereik



Artikel	D	K	Info	VPE
MD31.5003.01.500	6	3,2-6,4	staal verzinkt	500
MD31.5003.20.500	6	3,2-6,4	RVS	500
MD31.5004.20.500	6	4,8-7,9	RVS	500
MD31.5006.20.500	6	8,0-11, 2	RVS	500
MD31.5003.30.500	6	3,2-6,4	aluminium	500
MD31.5004.30.500	6	4,8-7,9	aluminium	500
MD31.5006.30.500	6	8,0-11, 2	aluminium	500

sluitring huck



Artikel	D	L	Info	VPE
MD31.5108.30.500	6	10	aluminium	500
MD31.5108.01.500	6	10	staal verzinkt	500
MD31.5108.20.500	6	10	RVS	500

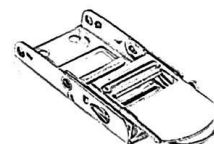

tegenplaat
gaten: 6,5mm

Artikel	A	L	B	s	Info	VPE
MD31.2528.20.100	28	45	20	1,5	RVS	100
MD31.2928.20.100	28	45	20	1,5	RVS	100



sluitring

Artikel	d	D	s	Info	VPE
MD31.5322.20.500	7,4	22	1,5	RVS - bol	500
MD31.5322.01.500	7,4	22	1,5	staal verzinkt - bol	500
MD31.5422.01.500	7,4	22	1,5	staal verzinkt - plat	500



anti-vandalisme kabel
lasbaar

Artikel	Info	VPE
MD31.4225.51.150	transparant	150



kederbuis type R27
incl. koper adaptor
vierkant 12 x 12mm

Artikel	D	L	Info	VPE
MD31.8030.11.1	27	3,0 m	aluminium	1
MD31.8033.11.1	27	3,3 m	aluminium	1

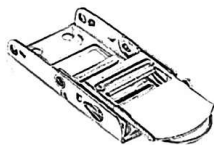

kederbuis type R27
voor keder 13mm



Artikel	D	L	Info	VPE
MD31.1227.30.1	27	2,7 m	aluminium	1
MD31.1230.30.1	27	3,0 m	aluminium	1
MD31.1233.30.1	27	3,3 m	aluminium	1

adaptor boven R27



Artikel	D	L	Info	VPE
MD31.0827.30.1	27	60	aluminium - pos. 1	1
MD31.0231.01.1	35	55	staal verzinkt - pos. 2	1

adaptor onder R27
koper

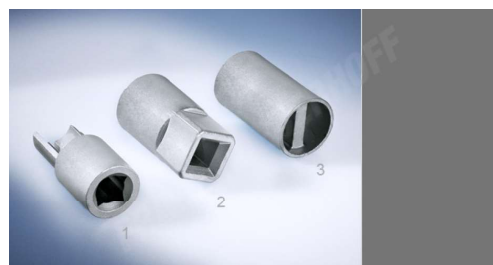

Artikel	D	L	Info	VPE
MD31.0832.11.1	27	60	aluminium - pos. 1	1
MD31.7832.11.1	27	60	aluminium - pos. 2	1

kederbuis type R34
voor keder 13mm



Artikel	D	L	Info	VPE
MD31.0227.30.1	34	2,7 m	aluminium	1
MD31.0230.30.1	34	3,0 m	aluminium	1
MD31.0236.30.1	34	3,3 m	aluminium	1

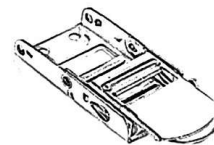

adaptor boven R34

Artikel	D	L	Info	VPE
MD31.0426.11.1	34	55	koper - pos. 1	1
MD31.0436.11.1	34	120	koper - pos. 2	1
MD31.0240.01.1	40	55	staal verzinkt - pos. 3	1



adaptor onder R34

Artikel	D	L	Info	VPE
MD31.0434.11.1	34	55	koper - pos. 1	1
MD31.0435.11.1	34	55	koper - pos. 2	1



horizontale spanner m069
voor beide zijdes

Artikel	H	L	B	Info	VPE
MD31.0180.01.1	35	120	48	staal verzinkt - vierkant	1
MD31.0280.01.1	40	120	48	staal verzinkt - sleuf	1



horizontale spanner m50h
voor beide zijdes

Artikel	H	L	B	Info	VPE
MD31.1112.01.1	50	120	45	staal verzinkt - vierkant	1
MD31.1125.01.1	50	120	45	staal verzinkt - sleuf	1

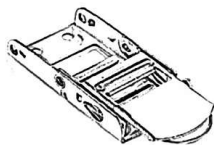

horizontale spanner m50k
voor beide zijdes
incl. zwengel



Artikel	H	L	B	Info	VPE
MD31.0112.01.1	50	120	45	staal verzinkt - vierkant	1
MD31.0125.01.1	50	120	45	staal verzinkt - sleuf	1
MD31.5012.01.1		200		staal verzinkt - enkel zwengel	1

horizontale spanner
links voor - rechts achter



Artikel	H	L	B	Info	VPE
MD31.0190.01.1	36	132	50	staal verzinkt - vierkant	1
MD31.0170.01.1	36	132	50	staal verzinkt - sleuf	1

horizontale spanner
rechts voor - links achter



Artikel	H	L	B	Info	VPE
MD31.0290.01.1	36	132	50	staal verzinkt - vierkant	1
MD31.0270.01.1	36	132	50	staal verzinkt - sleuf	1

horizontale spanner
links voor - rechts achter



Artikel	H	L	B	Info	VPE
MD31.0145.01.1	50	160	70	staal verzinkt - sleuf	1
MD31.0144.01.1	40	160	70	staal verzinkt - sleuf	1

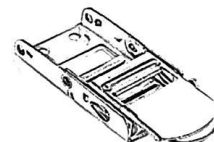

horizontale spanner
rechts voor - links achter

Artikel	H	L	B	Info	VPE
MD31.0245.01.1	50	160	70	staal verzinkt - sleuf	1
MD31.0244.01.1	40	160	70	staal verzinkt - sleuf	1



horizontale spanner
links voor - rechts achter

Artikel	H	L	B	Info	VPE
MD31.1144.01.1	40	160	70	staal verzinkt - vierkant	1

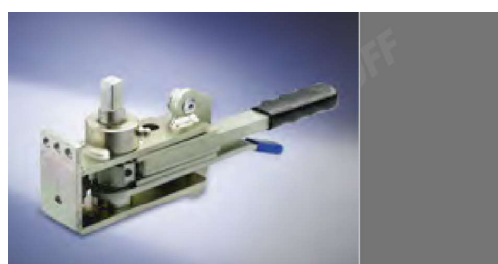

horizontale spanner
rechts voor - links achter

Artikel	H	L	B	Info	VPE
MD31.1244.01.1	40	160	70	staal verzinkt - vierkant	1



lasband
gesneden 1.300kg

Artikel	L	B	s	Info	VPE
MD31.4145.45.100	100 m	48	0,8	grijs	100
MD31.4145.43.100	100 m	48	0,8	zwart	100
MD31.4145.42.100	100 m	48	0,8	wit	100

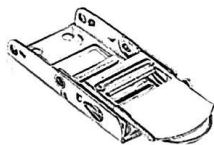

lasband
gewoven 1.300kg

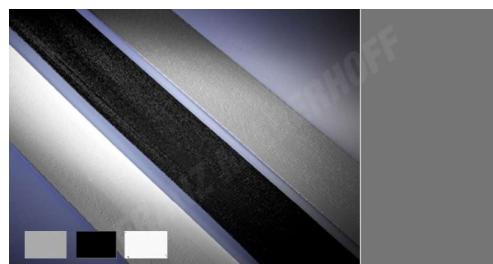

Artikel	L	B	s	Info	VPE
VT31.4045.45.100	100 m	48	1	grijs	100
VT31.4045.43.100	100 m	48	1	zwart	100
VT31.4045.42.100	100 m	48	1	wit	100
VT31.4023.42.100	100 m	23	1	wit - 600kg	100

lasband
gewoven 2.400kg

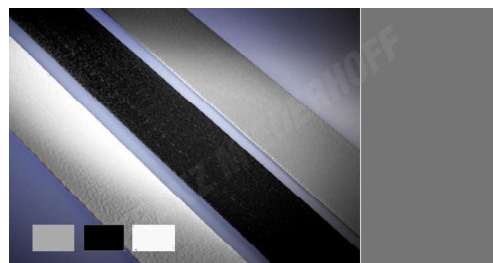

Artikel	L	B	s	Info	VPE
VT31.4050.45.100	100 m	48	1,5	grijs	100
VT31.4050.43.100	100 m	48	1,5	zwart	100
VT31.4050.42.100	100 m	48	1,5	wit	100

bevestigingsschroef
voor gordijnrails



Artikel	D	L	Info	VPE
MD10.0610.30.1	10	20	aluminium	1
MD10.0612.30.1	12	20	aluminium	1

keder
dubbele vlag - r = 4.000n/5cm

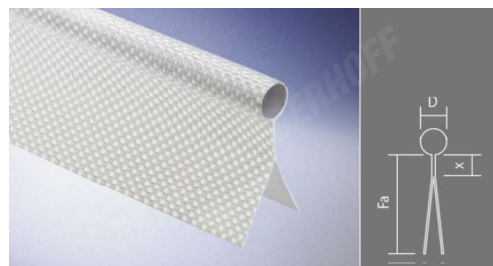

Artikel	D	L	Info	VPE
MD10.1113.82.150	13	150 m	wit	150

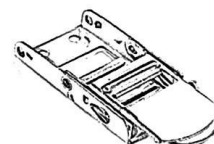

beschermingsprofiel
v-uitvoering

Artikel	L	Info	VPE
MD31.0128.30.1	3,5 m	aluminium	1



rail type a
voor afsluitrubber BR33P
& runner MD31.3445.01

Artikel	H	L	B	Info	VPE
MD31.2992.30.1	72	7 m	92	aluminium	1

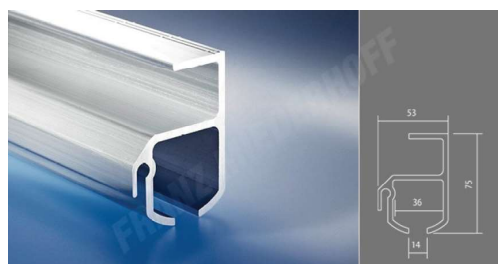

rail type b

Artikel	H	L	B	Info	VPE
MD31.2975.30.1	75	7 m	53	aluminium	1



rail type c

Artikel	H	L	B	Info	VPE
MD31.3192.30.1	45	7 m	92	aluminium	1

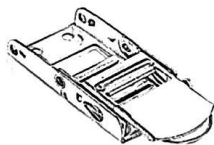

rail type 50

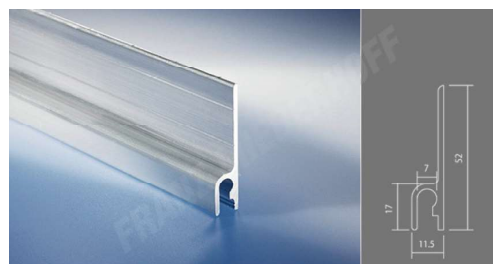

Artikel	H	L	B	Info	VPE
MD31.2950.30.1	52	7,5 m	11	aluminium	1

rail type 40
40 x 50 x 2mm



Artikel	H	L	B	Info	VPE
MD31.2840.01.1	53	7 m	43	staal verzinkt	1

inhaakprofiel type be
te gebruiken met keder 13mm

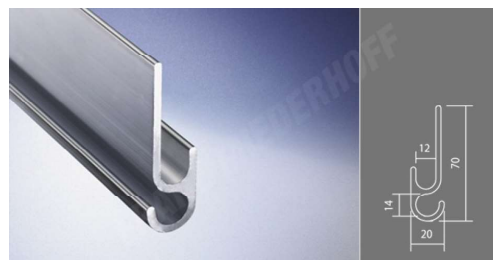

Artikel	H	L	B	Info	VPE
MD31.0327.30.1	20	2,7 m	70	aluminium	1
MD31.0360.30.1	20	3 m	70	aluminium	1
MD31.0363.30.1	20	3,3 m	70	aluminium	1

inhaakprofiel type de
te gebruiken met keder 13mm



Artikel	H	L	B	Info	VPE
MD31.0727.30.1	19	2,7 m	61	aluminium	1
MD31.0730.30.1	19	3 m	61	aluminium	1
MD31.0736.30.1	19	3,3 m	61	aluminium	1

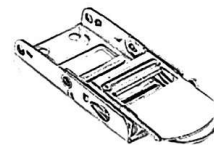

inhaakprofiel type ae
te gebruiken met keder 13mm

Artikel	H	L	B	Info	VPE
MD31.0127.30.1	19	2,7 m	61	aluminium	1
MD31.0130.30.1	19	3 m	61	aluminium	1
MD31.0136.30.1	19	3,3 m	61	aluminium	1

32 Oprolsysteem ROLLFIX



1 aluminium kederprofiel

2 keder voor rollfix

3 zwenkel

4 verlengstuk vierkant

5 verbindingsstuk

6 bevestigingsschroef



3

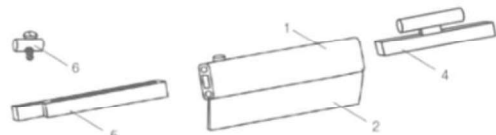
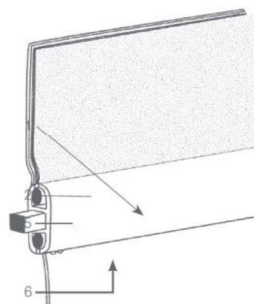

- optimale oplossing voor het oprollen van grote oppervlakken
- bespaart ruimte voor het laden en lossen
- betrouwbaar
- tijdsbesparend



aluminium kederprofiel
voor 7,5 - 10mm keder



Artikel	H	L	B	Info	VPE
MD10.0525.30.1	17	2,5 m	44	aluminium	1
MD10.0525.30.10	17	2,5 m	44	aluminium	10
MD10.0544.30.1	17	6 m	44	aluminium	1
MD10.0544.30.10	17	6 m	44	aluminium	10

keder voor rollfix
enkele vlag - $r = 4.000n/5cm$

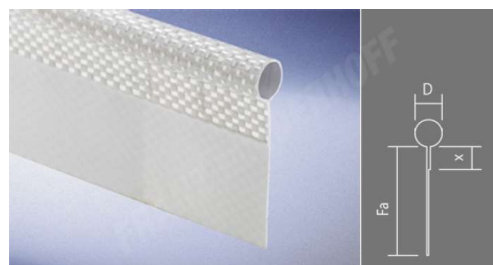

Artikel	D	L	Fa	x	Info	VPE
MD10.0115.82.1	10	15	55	20	wit	1
MD10.0110.82.150	10	150	55	20	wit	150

kunststof eindstop
voor kederprofiel MD10.0544.30



Artikel	Info	VPE
MD32.1305.44.1	grijs	1

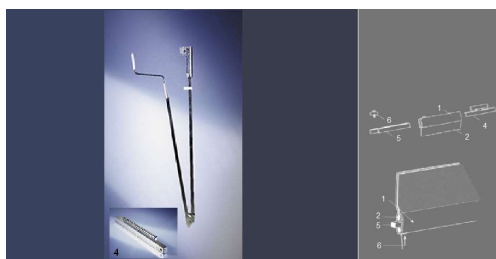

extra onderdelen
voor oprolsysteem rollfix

Artikel	L	Info	VPE
MD32.0613.01.1	1,3 m	zwengel - overbrenging 7:1	1
MD32.0624.01.1	2,4 m	zwengel - overbrenging 7:1	1
MD32.0627.01.1	2,7 m	zwengel - overbrenging 7:1	1
MD32.0631.01.1	3,1 m	zwengel - overbrenging 7:1	1
MD32.1324.01.1	2,4 m	zwengel - overbrenging 13:1	1
MD32.1327.01.1	2,7 m	zwengel - overbrenging 13:1	1
MD32.1361.01.1	3,1 m	zwengel - overbrenging 13:1	1
MD32.0220.01.1	0,2 m	verlengstuk alu profiel - pos. 4	1
MD32.0230.01.1	0,3 m	verbindingsstuk - pos. 5	1
MD10.0610.30.1		bevestigingsschroef - pos. 6	1
MD32.0807.01.1		vervangingsonderdeel - voor zwengel 7:1	1
MD32.0813.01.1		vervangingsonderdeel - voor zwengel 13:1	1

33 Oprolsysteem ROLL UP met veer

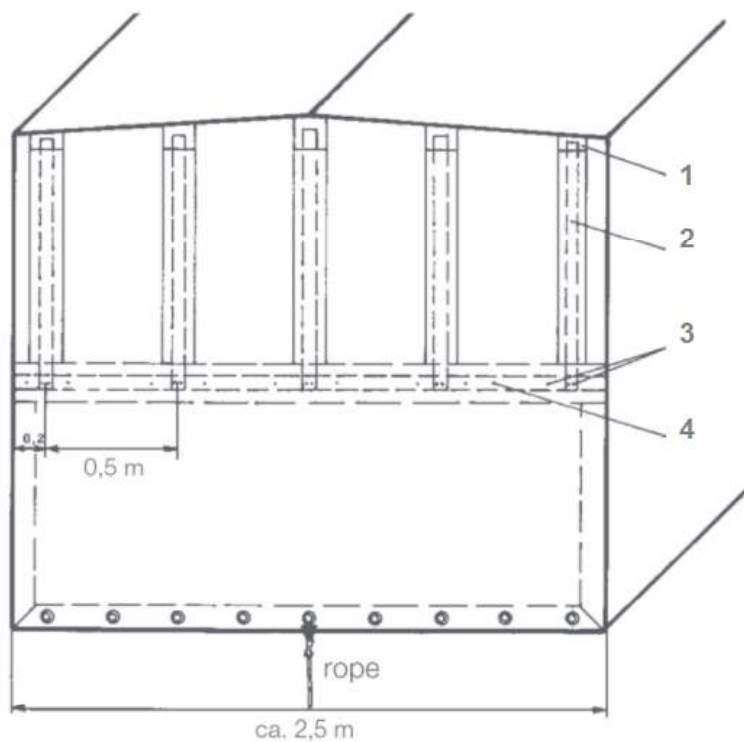

1. bescherm-pad pvc
2. RVS veer
3. Polygrip niet MD05.2715.30.250
4. aluminium kederprofiel

Het oprolsysteem is een beproefd systeem om het achterste dekzeil van een vrachtwagen of oplegger zeer snel te openen.
Dit door gebruik te maken van veren.

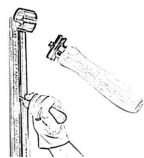

veer & beschermpad



Artikel	L	B	Info	VPE
MD32.1005.20.1	500	40	RVS - pos. 1	1
MD32.1006.20.1	600	40	RVS - pos. 1	1
MD32.1011.20.1	1100	40	RVS - pos. 1	1
MD32.1015.20.1	1500	40	RVS - pos. 1	1
MD32.1020.20.1	2000	40	RVS - pos. 1	1
MD32.1023.20.1	2300	40	RVS - pos. 1	1
MD32.1201.00.1	60	60	beschermpad pvc - pos. 2	1

aluminium kederprofiel
voor 7,5 - 10mm keder



Artikel	H	L	B	Info	VPE
MD10.0525.30.1	17	2,5 m	44	aluminium	1
MD10.0525.30.10	17	2,5 m	44	aluminium	10
MD10.0544.30.1	17	6 m	44	aluminium	1
MD10.0544.30.10	17	6 m	44	aluminium	10

verbindingsstuk vierkant
voor aluminium kederprofiel
17 x 44mm



Artikel	L	Info	VPE
MD32.0220.01.1	200		1

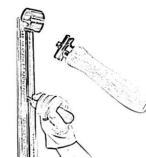

kunststof eindstop
voor kederprofiel
MD10.0544.30

Artikel	L	B	Info	VPE
MD32.1305.44.1	44	17	grijs	1



montage
rail & handvat

Artikel	L	B	Info	VPE
MD32.1113.01.1	1300	52	staal verzinkt - pos. 1	1
MD32.1120.01.1	2000	52	staal verzinkt - pos. 1	1
MD32.1108.00.1	200		houten handvat - pos. 2	1

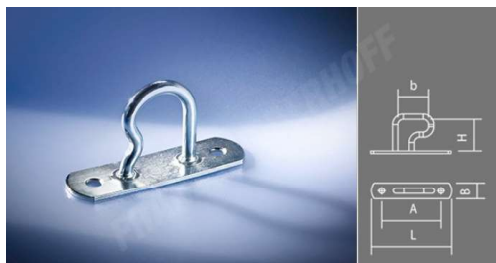

beugel
te gebruiken met RVS veren

Artikel	H	b	A	L	B	Info	VPE
MD02.3630.01.100	30	21	51	71	20	staal verzinkt	100
MD02.3630.20.100	30	21	51	71	20	RVS	100

34 Rolgordijn CURTAIN met kabel



Consoles zijn geschikt voor wand-, plafond- en nisopstelling (1). Stalen kabels zorgen ervoor dat het valprofiel wordt geleid (2).

Roestvrijstalen kabels worden aan de bovenkant van de montagebeugel (1) en aan de onderkant met de spanbeugel (3) aan de muurzijde bevestigd.

Het verzwaarde valprofiel (2) zorgt ervoor dat het gordijn schoon rolt. Aandrijving optioneel via krukmechanisme met afneembare handslinger (L = 1400) of radiomotor.

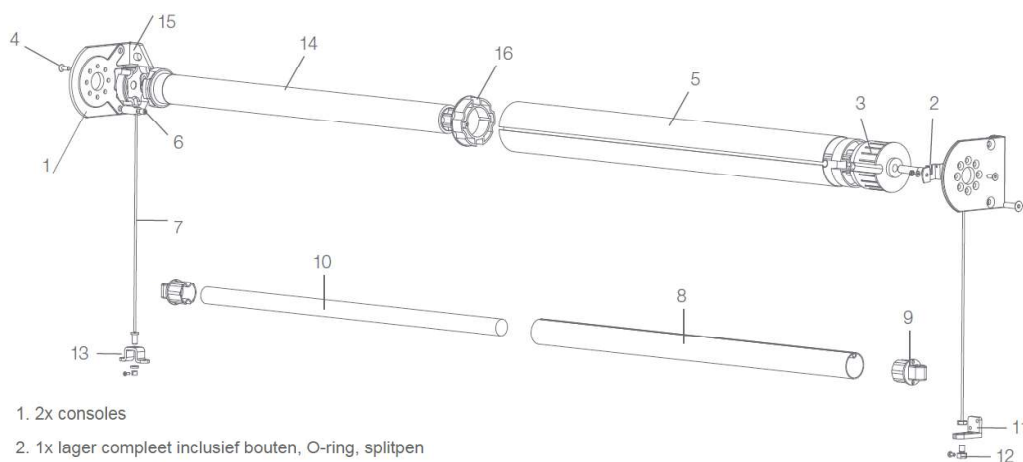

1. 2x consoles
2. 1x lager compleet inclusief bouten, O-ring, splitpen
2 verzonken schroeven M6 x 16.2 moer M6
3. 1x aandrijving voor as Ø 78 mm met gat Ø 14 mm
4. 2x verzonken schroef voor versnellingsbak / motorsteun M6 x 12
5. 1x stoffen schacht Ø 78 mm, individueel gesneden, lengte schacht stof = totale systeembreedte minder. 95 mm voor versnellingsbak of 80 mm voor motor
6. 2x touwhouder hierboven inclusief schroef M8
7. 1x staaldraad bedekt D: 3 mm; L: 12 mm
8. 1x valprofiel aluminium D: 40 mm, individueel gesneden, valprofiel lengte = totale systeembreedte minder. 100 mm
9. 2x eindpluggen voor valprofiel Ø 40 mm
10. Weging voor kofferprofiel, aantal afhankelijk van lengte d. Downpipe
11. 2x beugels voor wandmontage
12. 2x touw spanpot hieronder
13. 2x beugels voor vloermontage, optioneel
14. 1x buismotor Blue Wave 32 Nm radiogestuurd
1x handzender Skipper 1- kanaals
15. 1x motorsteun voor rolgordijn
16. 1x aandrijfset voor stoffen as Ø 78 mm

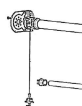

rolgordijn kabel
met zwengel



Artikel	B	Info	VPE
MD32.3020.42.1	tot 2 m	wit	1
MD32.3030.42.1	tot 3 m	wit	1
MD32.3040.42.1	tot 4 m	wit	1
MD32.3050.42.1	tot 5 m	wit	1
MD32.3020.45.1	tot 2 m	grijs	1
MD32.3030.45.1	tot 3 m	grijs	1
MD32.3040.45.1	tot 4 m	grijs	1
MD32.3050.45.1	tot 5 m	grijs	1

rolgordijn kabel
met motor & afstandsbediening



Artikel	B	Info	VPE
MD32.4020.42.1	tot 2 m	wit	1
MD32.4030.42.1	tot 3 m	wit	1
MD32.4040.42.1	tot 4 m	wit	1
MD32.4050.42.1	tot 5 m	wit	1
MD32.4020.45.1	tot 2 m	grijs	1
MD32.4030.45.1	tot 3 m	grijs	1
MD32.4040.45.1	tot 4 m	grijs	1
MD32.4050.45.1	tot 5 m	grijs	1

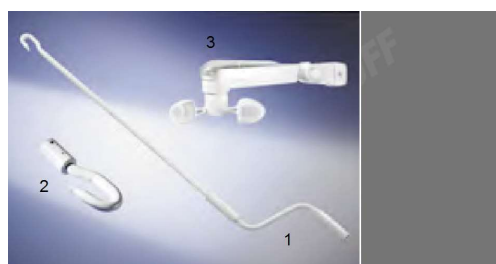
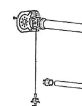

extra onderdelen
voor rolgordijn kabel

Artikel	L	Info	VPE
MD32.3000.00.1	3 m	wit - zwengel (pos. 1)	1
MD32.3014.00.1		wit - haak voor zwengel (pos. 2)	1
MD32.4042.02.1		wit - vloerbeugel (pos. 13)	1
MD32.0144.42.1		wit - radiozender	1
MD32.0143.42.1		wit - afstandsbediening	1
MD32.0032.42.1		wit - windhaan (pos. 3)	1

35 Rolgordijn CURTAIN met U-profiel

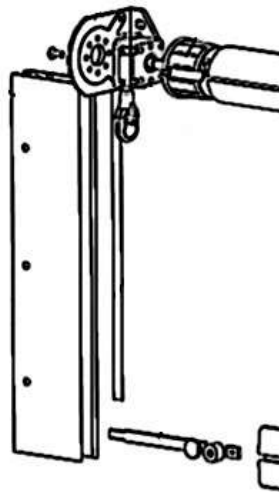

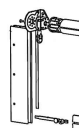

rolgordijn u-profiel
met zwengel



Artikel	H	B	Info	VPE
MD32.5020.42.1	2,5 m	tot 2 m	wit	1
MD32.5030.42.1	2,5 m	tot 3 m	wit	1
MD32.5040.42.1	2,5 m	tot 4 m	wit	1
MD32.5050.42.1	2,5 m	tot 5 m	wit	1
MD32.5420.42.1	4 m	tot 2 m	wit	1
MD32.5430.42.1	4 m	tot 3 m	wit	1
MD32.5440.42.1	4 m	tot 4 m	wit	1
MD32.5450.42.1	4 m	tot 5 m	wit	1

rolgordijn u-profiel
met motor & afstandsbediening



Artikel	H	B	Info	VPE
MD32.6020.42.1	2,5 m	tot 2 m	wit	1
MD32.6030.42.1	2,5 m	tot 3 m	wit	1
MD32.6040.42.1	2,5 m	tot 4 m	wit	1
MD32.6050.42.1	2,5 m	tot 5 m	wit	1
MD32.6420.42.1	4 m	tot 2 m	wit	1
MD32.6430.42.1	4 m	tot 3 m	wit	1
MD32.6440.42.1	4 m	tot 4 m	wit	1
MD32.6450.42.1	4 m	tot 5 m	wit	1

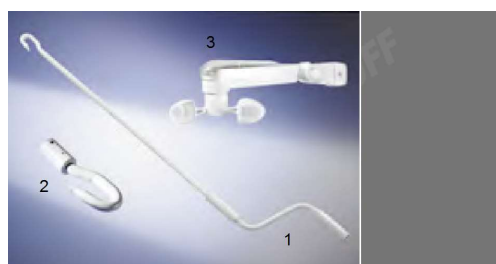
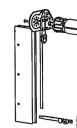

extra onderdelen
voor rol gordijn u-profiel

Artikel	L	Info	VPE
MD32.3000.00.1	3 m	wit - zwenkel (pos. 1)	1
MD32.3014.00.1		wit - haak voor zwenkel (pos. 2)	1
MD32.0144.42.1		wit - radiozender	1
MD32.0143.42.1		wit - afstandsbediening	1
MD32.0032.42.1		wit - windhaan (pos. 3)	1
MD32.8013.42.1	2,9 m	wit - keder rail (optioneel - pos 25)	1
MD32.8012.42.1	4,9 m	wit - keder rail (optioneel - pos 25)	1
MD32.8006.42.1	6,0 m	wit - keder rail (optioneel - pos 25)	1